





Tyre trolley

Application	Tyre storage method	Maximum load	Capacity	Coating
				

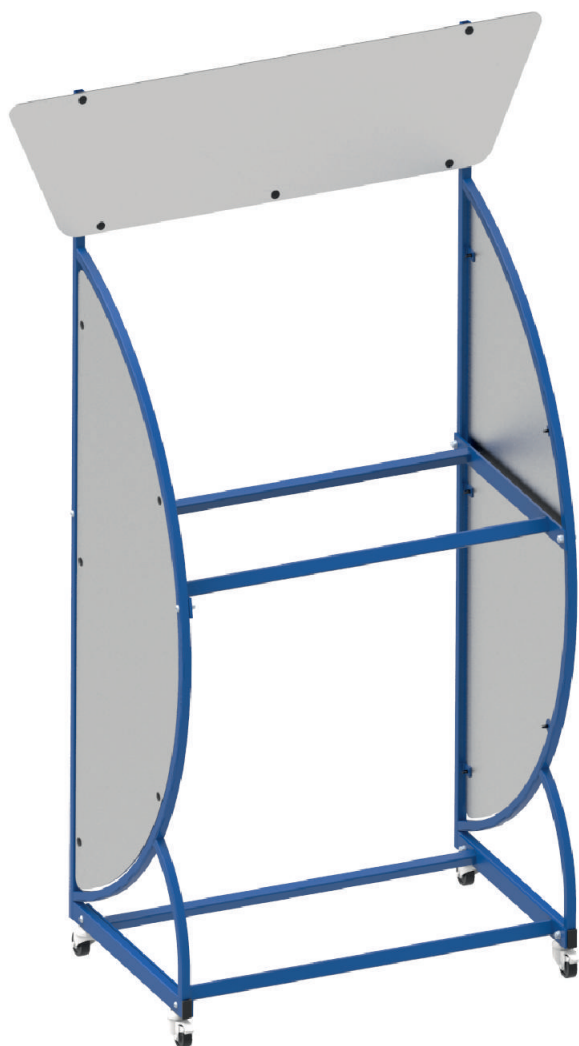

DIMENSIONS	LENGHT	WIDTH	HEIGHT
AR37	1130	557	1823

TECHNICAL DATA

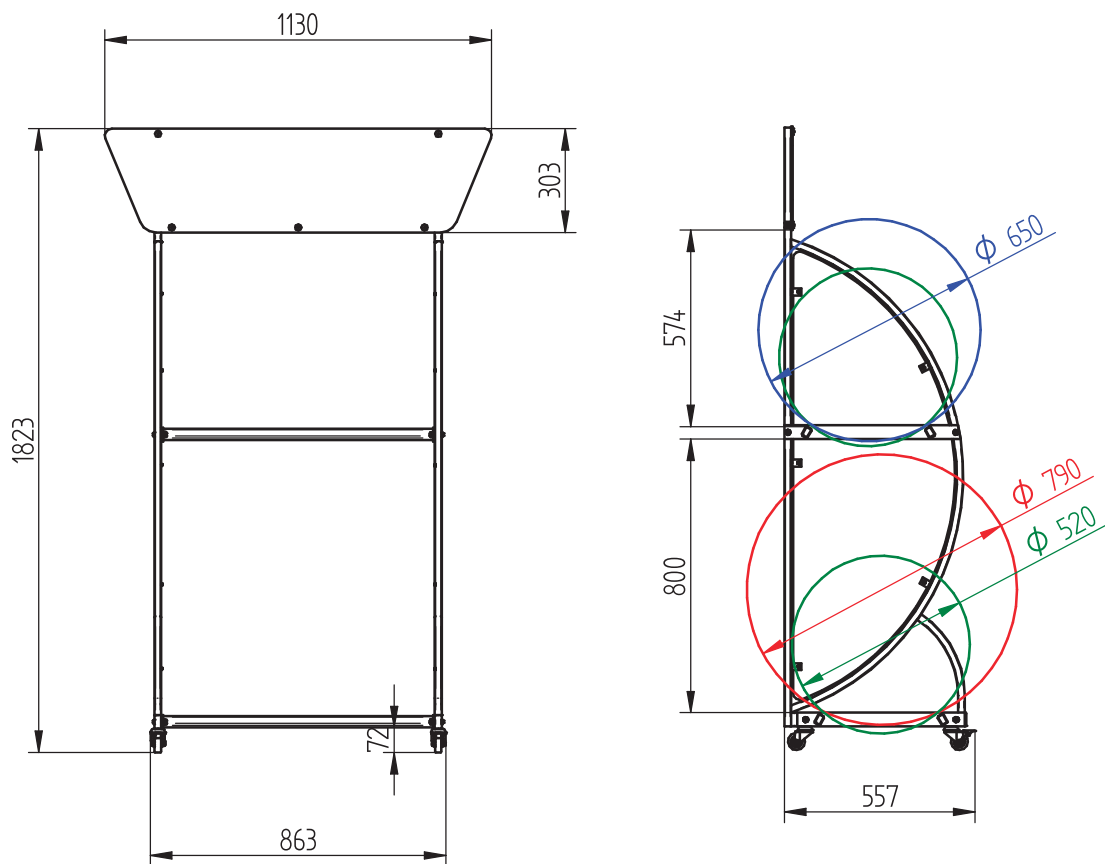

ACCESSORIES AND VARIANTS



TRANSPORT

