







## Tyre trolley

Application	Tyre storage method	Maximum load	Capacity	Coating
				 



DIMENSIONS	LENGHT	WIDTH	HEIGHT
AR35/4	1363	754	2142

## TECHNICAL DATA

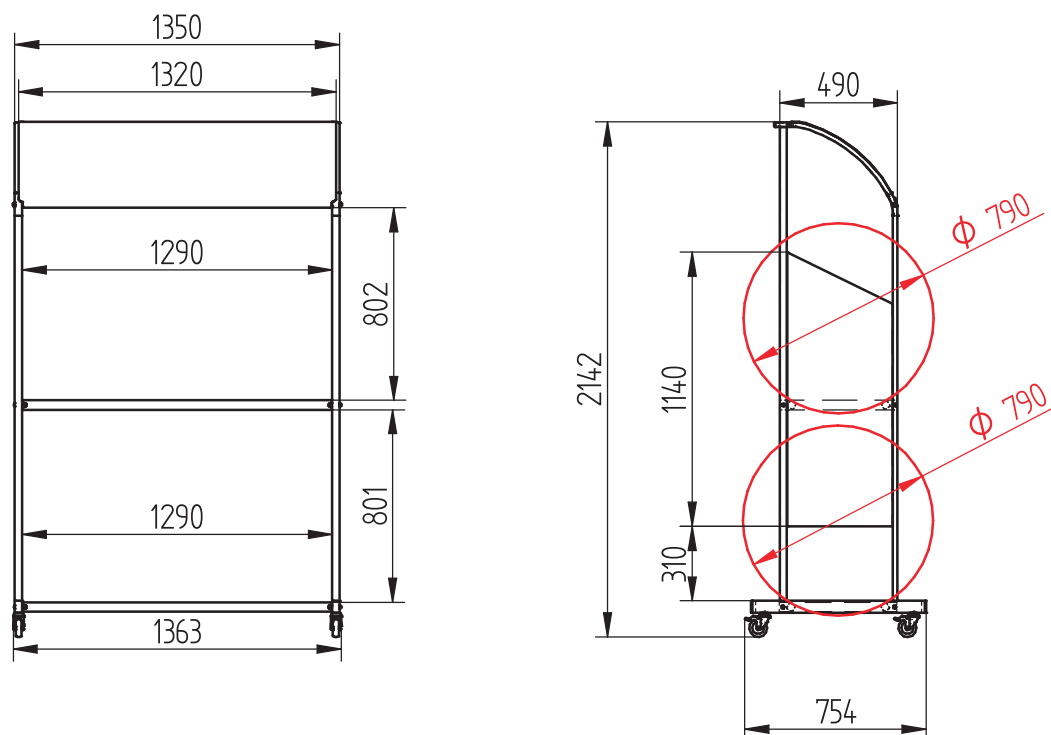

## ACCESSORIES AND VARIANTS



## TRANSPORT

